

E-M-CRP5-V1_02_EN.docx Document Code	Rotronic AG Bassersdorf, Switzerland Unit
CRP5 Clean Room Panel Instruction Manual Document Title	Instruction Manual Document Type
	Page 1 of 39

CRP5 Clean Room Panel

Instruction Manual



E-M-CRP5-V1_02_EN.docx Document Code	Rotronic AG Bassersdorf, Switzerland Unit
CRP5 Clean Room Panel Instruction Manual Document Title	Instruction Manual Document Type
	Page 2 of 39

Contents

1	Short Description of the Product	3
1.1	Delivery Package.....	4
1.2	Main Features of the CRP5	5
1.3	Technical Drawings	6
2	General Description	7
2.1	Connections.....	7
2.2	Differential Pressure Measurement	9
2.3	HC2-CRP and HC2 Connection	11
2.4	Analog Inputs.....	11
2.5	Ambient Pressure.....	11
2.6	Analog Outputs.....	12
2.7	Digital Inputs.....	12
2.8	Relays	13
2.9	Digital Interface – Modbus RTU.....	13
2.10	Service Interface.....	13
2.11	Display and Keys.....	14
3	Mechanical Installation	16
3.1	General.....	16
3.2	Installation in the Wall.....	16
3.3	Differential Pressure Connection	16
3.4	HC2-CRP Connection	17
3.5	HC2 Connection	18
4	Information on Use.....	19
4.1	Signal Cables	19
4.2	Differential Pressure Measurement	20
4.3	Scaling of the Analog Inputs.....	20
4.4	Menu Mode.....	26
4.5	Service Socket.....	31
4.6	Validation of Analog Output Signals	31
4.7	Replacement of the HC2-CRP Teflon Filter.....	32
5	Firmware Update	33
6	Technical Data	34
7	Accessories	37
8	Additional Documents	39
9	Document Versions.....	39

E-M-CRP5-V1_02_EN.docx Document Code	Rotronic AG Bassersdorf, Switzerland Unit
CRP5 Clean Room Panel Instruction Manual Document Title	Instruction Manual Document Type Page 3 of 39

Scope:

This manual is valid for the CRP5 clean room panel series with firmware version V1.x. The latest firmware release can be found at www.rotronic.com.





1 Short Description of the Product

The CRP5 is a multifunctional clean room panel for the monitoring and control of all essential parameters of a clean room in research, development and production. The most important measurements are the high-precision determination of (differential) air pressure, relative humidity and temperature in clean rooms. The device also has analogue and digital inputs and outputs for connection of external sensors, actuators, alarm transmitters, etc. The sophisticated integrated signal processing with calculation of all psychrometric parameters in combination with the ROTRONIC HW4 user software makes the CRP5 a universal measurement and control centre for every clean room. The measurement results can be shown in the built-in colour display with four visual keys. An external HygroClip2 temperature and humidity probe can be connected optionally. Configurable alarms can control up to six volt-free relay contacts.

The CRP5 can be flush-mounted airtight in a clean room wall. The electronics including display and visual keys are housed completely behind a solid glass panel. A combined probe in stainless steel housing with sensors for relative humidity and temperature of the clean room atmosphere can be fastened on the glass panel firmly and without risk of mix-up with a magnetic holder (no need for tools). Contact is established with gold-plated spring pins and is gastight. Two stainless steel pressure connections permit calibration and adjustment of the device from the clean room.

E-M-CRP5-V1_02_EN.docx Document Code	Rotronic AG Bassersdorf, Switzerland Unit
CRP5 Clean Room Panel Instruction Manual Document Title	Instruction Manual Document Type Page 4 of 39

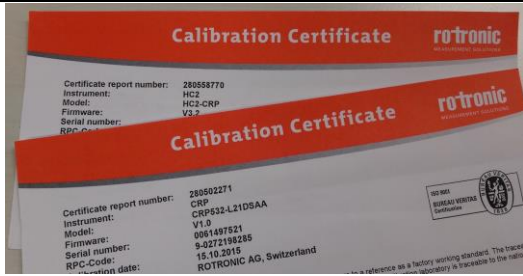
1.1 Delivery Package

CRP5 clean room panel Depending on order code, with / without HC2-CRP	
Mounting kit 2 pc. wall holders 290 mm x 10 mm x 3 mm	
Mounting screws 4 pc. PEEK M4x16	
Factory adjustment certificate	
Short instruction manual	
Screw terminals	

E-M-CRP5-V1_02_EN.docx Document Code	Rotronic AG Bassersdorf, Switzerland Unit
CRP5 Clean Room Panel Instruction Manual Document Title	Instruction Manual Document Type
	Page 5 of 39

1.2 Main Features of the CRP5

- High-precision measurement and long-term stability
- Short response time and low hysteresis
- Colour TFT LCD
- Analog input and output signals freely configurable
- Digital inputs and outputs
- Volt-free semiconductor relay switch contacts
- Large overload range
- Alternative connection for remote HygroClip2 (humidity, temperature or analog signals)
- Removable combined humidity and temperature probe for simple cleaning
- High immunity to dust and humidity in the environment

The user can update the firmware to keep the CRP5 state-of-the-art at all times.

The following diagram shows the function blocks:

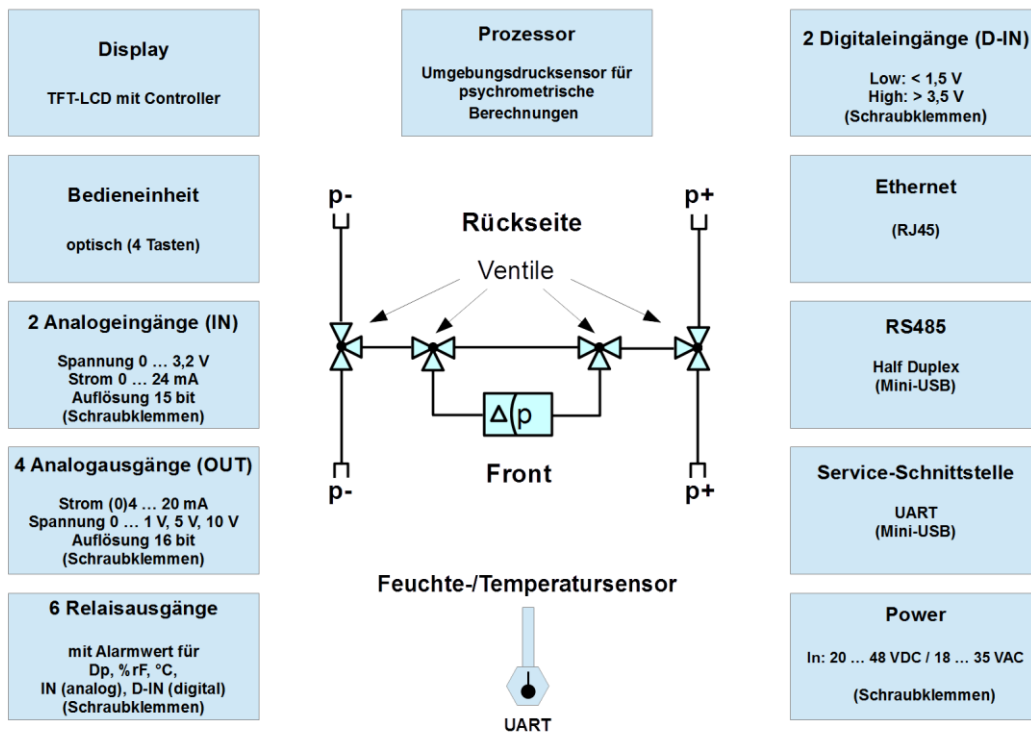

Legende: UART = Universal Asynchronous Receiver Transmitter; TFT-LCD = Thin Film Transistor – Liquid Crystal Display

Figure 1: Overview of the function blocks of the CRP5 clean room panel

E-M-CRP5-V1_02_EN.docx	Rotronic AG Bassersdorf, Switzerland
Document Code	Unit
CRP5 Clean Room Panel Instruction Manual	Instruction Manual Document Type
Document Title	Page 6 of 39

1.3 Technical Drawings

The CRP5 clean room panel is intended for mounting in walls or switch cabinet doors. The external dimensions are shown in the following drawings.

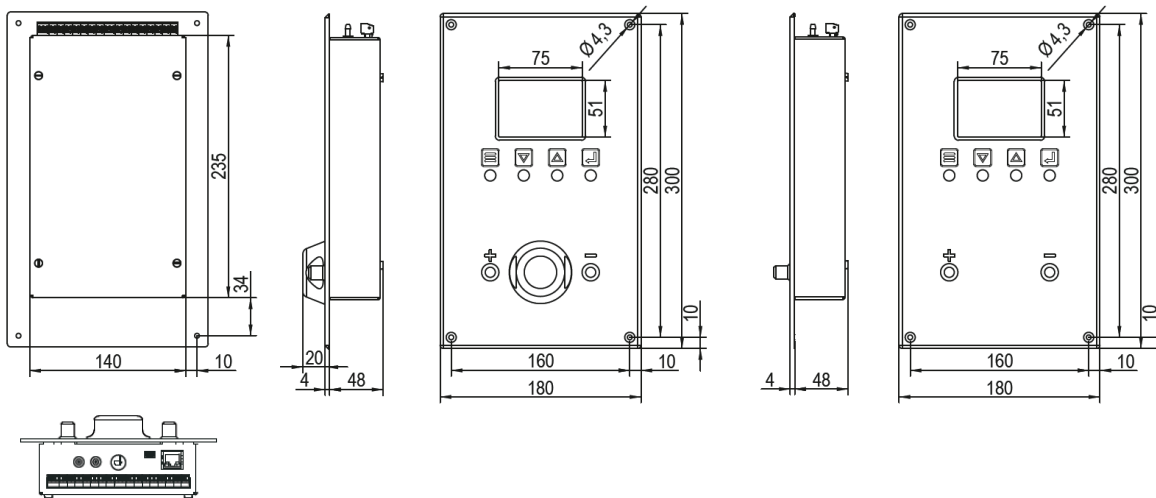

Figure 2: CRP5 dimensional drawings with HC2-CRP front panel probe (left) and E2 connection for external HC2 probe (right)

HC2-CRP

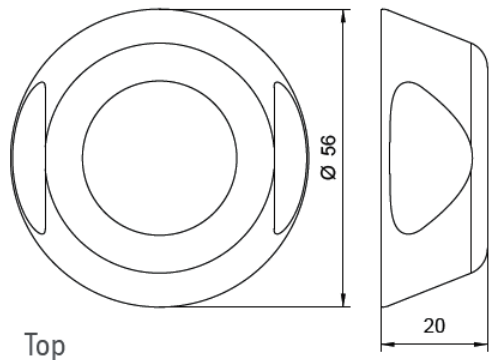

Figure 3: HC2-CRP dimensional drawing

HC2-CRP-HOLDER

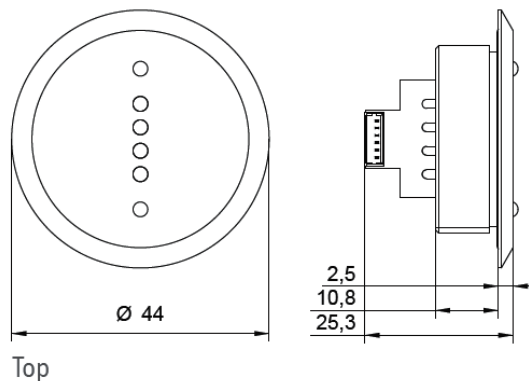

Figure 4: HC2-CRP-Holder dimensional drawing

E-M-CRP5-V1_02_EN.docx Document Code	Rotronic AG Bassersdorf, Switzerland Unit
CRP5 Clean Room Panel Instruction Manual Document Title	Instruction Manual Document Type
	Page 7 of 39

2 General Description

2.1 Connections

Front: The CRP5 is equipped with a combined probe (HC2-CRP) for relative humidity and temperature in a stainless steel housing that is fastened to the front panel without risk of mix-up with a magnetic holder. The probe is connected to the CRP5 electronics by four stainless steel spring pins. The HC2-CRP probe sends its measured values to the CRP5 electronic evaluation unit in digital form.



Figure 6: Front view of the CRP5 with front-side HC2-CRP probe



Figure 5: Rear view of the combined probe HC2-CRP with spring contact pins

Two stainless steel pressure connections labelled + and – on the right and left of the HC2-CRP probe permit calibration and adjustment of the device from the clean room. When not in use, they are closed with two stainless steel screw caps.

The CRP5 can **optionally** also be ordered without the front-side HC2-CRP combined probe. In this alternative there is a 7-pin connection socket at the back of the device for remote connection of a standard HC2 sensor (HygroClip 2) via a connection cable (e.g. probe extension cable E2-01A). The measured values are transmitted in digital and analog form.



Figure 7: Front view of CRP5 for remote HC2 probe

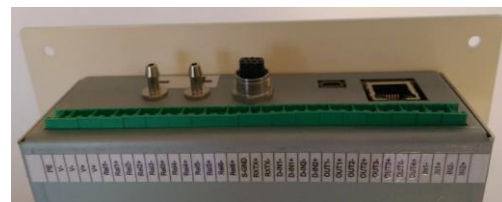

Figure 6: Connections at the rear

E-M-CRP5-V1_02_EN.docx	Rotronic AG Bassersdorf, Switzerland
Document Code	Unit
CRP5 Clean Room Panel Instruction Manual	Instruction Manual Document Type
Document Title	Page 8 of 39

Rear: A 36-pole connector strip with screw terminal blocks is used for rear connection of the CRP5. Their assignment is shown in the figure opposite. The rear of the device also has an RJ45 Ethernet socket for LAN integration, a Mini-USB service port (UART) for connection to a Windows PC/laptop running the ROTRONIC HW4 software via an optional AC3006 service cable, two pressure connection nipples and optionally a 7-pin connection socket for an external ROTRONIC HC2 HygroClip humidity and temperature sensor.

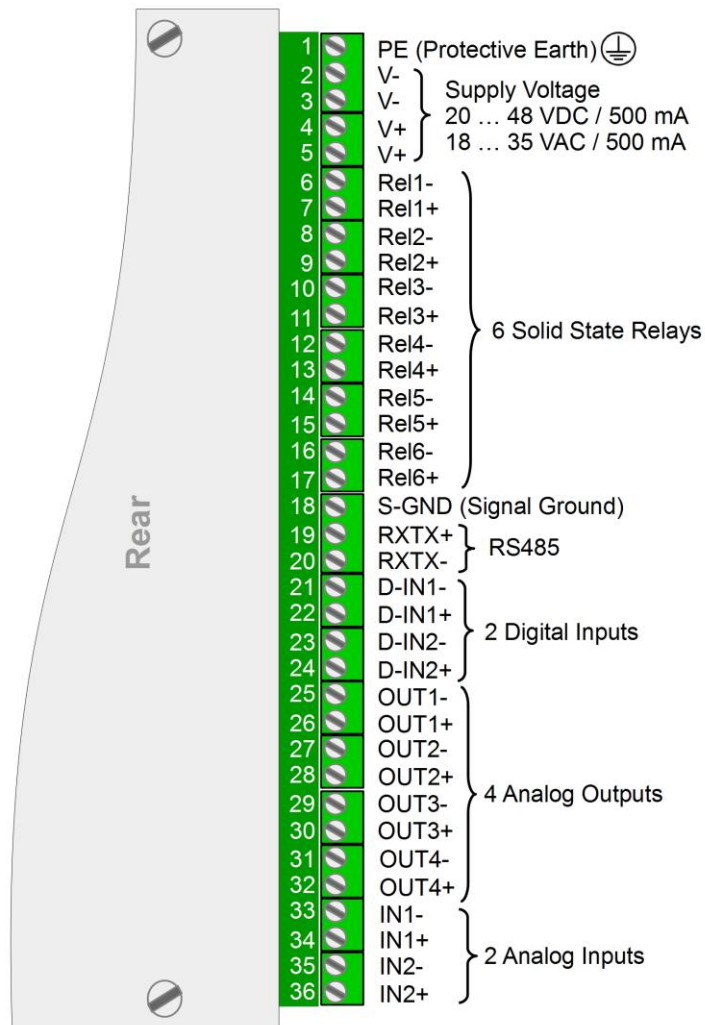

Figure 7: Assignment of the CRP5's rear terminal strip

Attention!

Regarding the grounding, all terminals marked with a minus sign (-) are connected commonly, this includes the power supply and the protective ground. Only the relay outputs and data connections are isolated.

E-M-CRP5-V1_02_EN.docx Document Code	Rotronic AG Bassersdorf, Switzerland Unit
CRP5 Clean Room Panel Instruction Manual Document Title	Instruction Manual Document Type
	Page 9 of 39



Figure 8: CRP5 connections with external HC2 probe

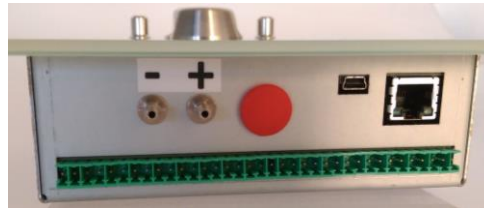

Figure 9: CRP5 connections with HC2-CRP

2.1.1 Power Supply / Current Consumption

The power supply for the CRP is connected via the screw contacts 2/3 (V-) and 4/5 (V+). Screw contact 1 is used to connect protective earth. The screw terminals are implemented in twos so that the supply voltage can be looped through to a further load should this be necessary.

Operating Voltage	Current Consumption
20 ... 48 VDC	<500 mA
18 ... 35 VAC / 50/60 Hz	<500 mA

Note:

The device does not have galvanic isolation.
The power supply is equipped with polarity protection.

2.2 Differential Pressure Measurement

The calibrated and thermally compensated differential pressure sensors used by ROTRONIC guarantee an exact and stable output signal over a wide temperature range.

The piezoresistive diaphragm sensor is based on the principle of MEMS. This guarantees high immunity to dust and avoidance of cross contamination between the two spaces in which the pressure is measured.

2.2.1 Measurement Ranges

The following sensor measurement ranges are available:

- -50 ... +50 Pa
- -100 ... +100 Pa
- -250 ... +250 Pa
- -500 ... +500 Pa

E-M-CRP5-V1_02_EN.docx Document Code	Rotronic AG Bassersdorf, Switzerland Unit
CRP5 Clean Room Panel Instruction Manual Document Title	Instruction Manual Document Type
	Page 10 of 39

2.2.2 Units

The following units are available for differential pressure: pascal (Pa), inch water column (inH₂O), pound per square inch (psi), millibar (mbar), mm mercury column (mmHg), mm water column (mmH₂O), torr (Torr), gram per square centimetre (g/cm²). The following table shows the conversion factors between the different units.

Unit	Pa	inH ₂ O	psi	mbar	mmHg	mmH ₂ O
1 Pa	1	4,015·10 ⁻³	145,0·10 ⁻⁶	10·10 ⁻³	7,501·10 ⁻³	102,0·10 ⁻³
1 inH ₂ O	249,1	1	36,13·10 ⁻³	2,491	1,868	25,40
1 psi	6,895·10 ³	27,68	1	68,95	51,71	703,1
1 mbar	100	401,5·10 ⁻³	14,50·10 ⁻³	1	750,1·10 ⁻³	10,20
1 mmHg	133,3	535,3·10 ⁻³	19,34·10 ⁻³	1,333	1	13,60
1 mmH ₂ O	9,806	39,37·10 ⁻³	1,422·10 ⁻³	98,06·10 ⁻³	73,55·10 ⁻³	1

Umrechnung gemäß <http://www.setuptranslator.com/einheiten-rechner.php?typ=druck>
Stand: 20.09.2015

Figure 10: Conversion of common pressure units

2.2.3 Smoothing Filter

The differential pressure measured value curve can be smoothed by forming a moving average (MA) over the latest measurements. Up to 10 measurements can be incorporated in the average value (greatest smoothing); the default setting is five measurements.

The current measured value is added up with the previous N-1 measured values and divided by N. When there is a new measured value, the oldest value in the measured value set is dropped from the calculation and the new measured value is added.

2.2.4 Simulation Value

When the simulation value has been activated, a defined simulation value is used instead of the current measured value. This makes it possible to test whether the CRP5 transmits a defined fictitious measured value to the monitoring system correctly to verify error-free communication.

E-M-CRP5-V1_02_EN.docx Document Code	Rotronic AG Bassersdorf, Switzerland Unit
CRP5 Clean Room Panel Instruction Manual Document Title	Instruction Manual Document Type
	Page 11 of 39

2.3 HC2-CRP and HC2 Connection

In the standard version of the device the HC2-CRP probe is connected on the front panel via a magnetic holder. The CRP5 can optionally be delivered with an alternative E2 connection socket at the rear for connection of a remote HC2 probe via a connection cable.

2.3.1 Units

The following units are available for the HC2-CRP and external HC2 connection:

- % RH
- °C / °F

2.3.2 Simulation Value

When the simulation value has been activated, a defined simulation value is used instead of the current measured value. This makes it possible to test correct transmission of measured values.

2.4 Analog Inputs

The two analog inputs 33/34 (IN1-/IN1+) and 35/36 (IN2-/IN2+) can be switched between voltage and current measurements. The respective input signals may not exceed a maximum signal amplitude of 0 ... 3.3 V (internal resistance >100 kΩ) or 0 ... 25 mA (measuring resistance 120 Ω, 0.1%) and are quantized with 15 bit.

Information!

The 120 Ohm burden for a current input is programmatically inserted and the user does not need to supply an external resistor.

2.5 Ambient Pressure

The ambient pressure sensor used features a short response time and high resolution. Its extreme long-term stability, combined with remarkable pressure resistance, guarantees years of precise and maintenance-free operation and exact psychrometric calculations.

Ambient Pressure Sensor	
Absolute accuracy	±1 hPa (0 ... 65 °C; 950 ... 1100 hPa) max.
Relative accuracy	0.12 hPa (25 °C; 950 ... 1050 hPa) typ.
Temperature coefficient offset	1.5 Pa/K (+25 ... 40 °C @ 900 hPa)
Working range - pressure	300 ... 1100 hPa
Working range - temperature	0 ... 65 °C

1.

E-M-CRP5-V1_02_EN.docx Document Code	Rotronic AG Bassersdorf, Switzerland Unit
CRP5 Clean Room Panel Instruction Manual Document Title	Instruction Manual Document Type
	Page 12 of 39

2.6 Analog Outputs

The ROTRONIC HW4 software enables free configuration and scaling of the four analog outputs 25/26 (OUT1-/OUT1+), 27/28 (OUT2-/OUT2+), 29/30 (OUT3-/OUT3+) and 31/32 (OUT4-/OUT4+). The measured values Differential Pressure, Relative Humidity, Temperature and Calculated Value and the input signals Analog Input 1, Analog Input 2, Digital Input 1 and Digital Input 2 can be assigned to any analog output and scaled at will.

The following output ranges are available:

Signal Type	Range	Maximum Offset at Start of Range
Voltage	0 ... 1 V	3 mV
	0 ... 5 V	50 mV
	0 ... 10 V	90 mV
Current	0 ... 20 mA	4 µA
	4 ... 20 mA	No offset

2.6.1 Scaling of the Measured Parameters

The scale can be changed at will with the ROTRONIC HW4 software in a range from -9,999 to +99,999. The limits of the sensor must, however, be observed.

The devices have one of the following optional default settings on delivery.

Analog Outputs	Operating Range of the Differential Pressure Sensor	Limit Values of the Differential Pressure Sensor
0 ... 10 V	-50 ... + 50 Pa	-60 ... +60 Pa
	0 ... +50 Pa	-60 ... +60 Pa
	-100 ... +100 Pa	-120 ... +120 Pa
	0 ... +100 Pa	-120 ... +120 Pa
or 4 ... 20 mA	-250 ... +250 Pa	-300 ... +300 Pa
	0 ... +250 Pa	-300 ... +300 Pa
	-500 ... +500 Pa	-600 ... +600 Pa
	0 ... +500 Pa	-600 ... +600 Pa

2.7 Digital Inputs

There are two digital inputs 21/22 (D-IN1-/D-IN1+) and 23/24 (D-IN2-/D-IN2+) available for logic signals with a maximum voltage range from 0 ... 24 VDC. The input resistance is 10 kΩ; input voltages <1.5 V are interpreted as logic "0" and >3.5 V as logic "1".

Digital Inputs	
Input voltage	0 ... 24 VDC
Input resistance	10 kΩ

E-M-CRP5-V1_02_EN.docx Document Code	Rotronic AG Bassersdorf, Switzerland Unit
CRP5 Clean Room Panel Instruction Manual Document Title	Instruction Manual Document Type
	Page 13 of 39

Switching threshold	>3.5 VDC (high, logic 1), <1.5 VDC (low, logic 0)
---------------------	---

2.8 Relays

The CRP5 provides six volt-free semiconductor relays (NO: normally open): 6/7 (REL1-/REL1+), 8/9 (REL2-/REL2+), 10/11 (REL3-/REL3+), 12/13 (REL4-/REL4+), 14/15 (REL5-/REL5+), 16/17 (REL6-/REL6+).

The relays can be controlled via freely configurable low/high alarms by the parameters Differential Pressure, Relative Humidity, Temperature, Calculated Parameters and the two analog and digital inputs. The following can also be set:

- **Time delay**
The relay is only switched on when an alarm endures for a certain minimum time.
- **Switch off when alarm finished**
The relay automatically disengages when the alarm is no longer active; otherwise the relay remains active until it is reset manually.
- **Maximum duty cycle**
The relay stays on for at most the time set and is then switched off.

Only one measured value can be used to activate a relay. Assignment of more than one measured value is not possible.

Relay Characteristics	
Number of relays	6
Type of relays	FET (solid state relay)
Switching capacity	DC voltage: 100 W (50 VDC @ 2 A), observe polarity AC voltage: 50 W (50 VAC (peak) @ 1 A), polarity arbitrary

2.9 Digital Interface – Modbus RTU

See separate manual D-M-CRP5-MODBUS.

2.10 Service Interface

A computer running the ROTRONIC HW4 software can be connected via the service interface (Mini-USB at the rear of the device, UART) using an AC3006 connection cable. It can then be used to make device settings, load language data and update the firmware.

Important:

The CRP5 can be supplied with power via the AC3006 service cable. However, the valves for zeroing and calibration as well as the analog outputs are not active in this case.

For sensor adjustment, the CRP5 must be supplied with power from a suitable power source.

E-M-CRP5-V1_02_EN.docx Document Code	Rotronic AG Bassersdorf, Switzerland Unit
CRP5 Clean Room Panel Instruction Manual Document Title	Instruction Manual Document Type
	Page 14 of 39

2.11 Display and Keys

The colours for the background and measured values in normal and alarm cases are freely selectable. There are six display lines available as follows:

- Line 1 ... 3: Differential pressure (Pa), relative humidity (%RH), temperature (°C)
- Line 4: Analog input values (IN1, IN2), calculated values (all psychrometric calculations), no value
- Line 5 ... 6: Ambient pressure (hPa), digital input values (D-IN1, D-IN2), no value







Figure 11: Operating keys and display in the CRP front panel

Example: The first line of the display shows the differential pressure, the second the relative humidity, the third the temperature and the fourth the calculated value for dew point. Arrows at the beginning of every line indicate the measured value trend:

↘ falling, ↗ rising, ↔ constant.

Line 5 is configured for the ambient pressure and line 6 for the logic level at digital input D-IN2.

Key Symbols:

-  MENU
-  Down (decrease value)
-  Up (increase value)
-  Enter (finish entry)

Note:

Unauthorized use of the menu via the keys on the front panel can be prevented with the ROTRONIC HW4 software: *Device Manager* > *Settings* > *Key Lock*. After entering an own password and confirming it with OK, the message "Menu blocked" appears in the display of the CRP5 when pressing the menu key and further pressing of keys has no effect.

2.11.1 Alarms

The display colour of measured values in an alarm state changes to a preselectable colour (e.g. red). Alarms are configured with the ROTRONIC HW4 software.

E-M-CRP5-V1_02_EN.docx Document Code	Rotronic AG Bassersdorf, Switzerland Unit
CRP5 Clean Room Panel Instruction Manual Document Title	Instruction Manual Document Type
	Page 15 of 39

2.11.2 Decimals

Depending on the size of the measured value, measured values are shown in the CRP5 display with one or two decimals.

2.11.3 HW4 Software Compatibility

The CRP5 clean room panel is fully integrated in the ROTRONIC HW4 software from Version 3.6 and later.

E-M-CRP5-V1_02_EN.docx Document Code	Rotronic AG Bassersdorf, Switzerland Unit
CRP5 Clean Room Panel Instruction Manual Document Title	Instruction Manual Document Type
	Page 16 of 39

3 Mechanical Installation

3.1 General

The CRP5 can be flush-mounted in a wall. The position of the device has no influence on measurement. For exact measurements, the CRP5 must not be exposed to vibrations.

3.2 Installation in the Wall

Cut a suitable opening and drill holes according to the technical drawing.

CAUTION! It is advisable **not to use metal screws** to prevent glass breakage due to excessive mechanical stresses.

Recommended accessories:

- 4 x M4x16 PEEK plastic countersunk screws with cross-head (polyetheretherketone, AC6102)
- Mounting holder (AC6101)



Figure 12: PEEK screws AC6102



Figure 13: Mounting holder AC6101

3.3 Differential Pressure Connection

Tubes with an internal diameter of 4 mm can be connected at the rear (front: 6 mm). The tubes must be fastened securely so that they do not move or vibrate during operation. This would falsify the measurement.

Marking of the differential pressure connections:

- + Positive pressure connection
- Negative pressure connection

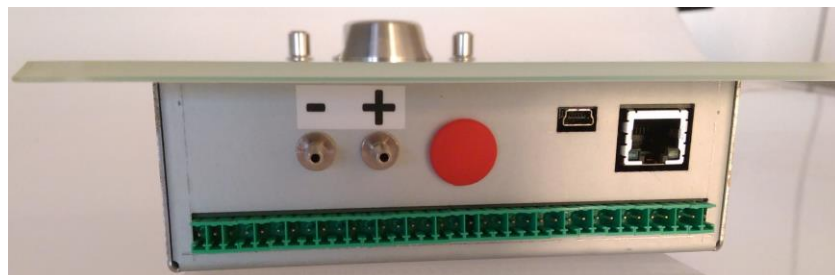

Figure 14: Differential pressure connections at the rear

E-M-CRP5-V1_02_EN.docx Document Code	Rotronic AG Bassersdorf, Switzerland Unit
CRP5 Clean Room Panel Instruction Manual Document Title	Instruction Manual Document Type
	Page 17 of 39

3.4 HC2-CRP Connection

The combined HC2-CRP humidity and temperature probe is connected at the front of the CRP5. It is fastened firmly and without risk of mix-ups on its holder by integrated magnets, and bonded to the electronics of the CRP5 by spring contact pins.

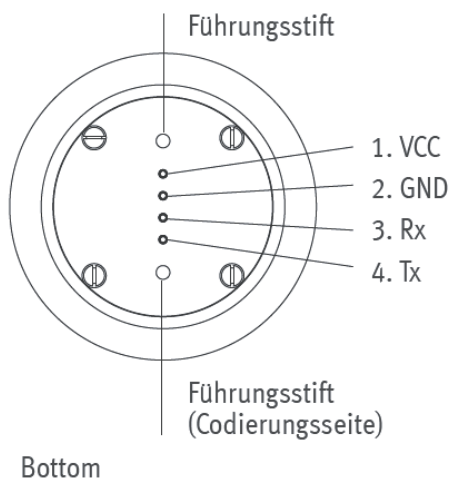

Figure 16: HC2-CRP connection

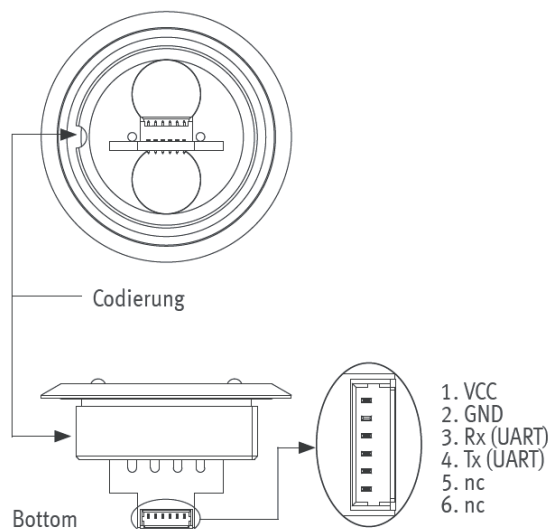

Figure 15: HC2-CRP-HOLDER connection



Figure 17: HC2-CRP rear



Figure 18: HC2-CRP-HOLDER rear

E-M-CRP5-V1_02_EN.docx Document Code	Rotronic AG Bassersdorf, Switzerland Unit
CRP5 Clean Room Panel Instruction Manual Document Title	Instruction Manual Document Type
	Page 18 of 39

3.5 HC2 Connection

Instead of a front-side HC2-CRP connection, the CRP5 can alternatively be ordered with an E2 socket at the rear for an external HC2 probe. This interface and its possible uses are described below.

3.5.1 Use with HC2 Probe

After connecting a remote HC2 probe to the rear E2 socket via an extension cable, it is possible to make the same measurements as with a HC2-CRP probe on the front panel: relative humidity and temperature. The digital measured data of the HC2 probe is evaluated by the CRP5.



Figure 19: Connection socket for an external HC2 probe

Pin Configuration E2 Connection (view from front)

The pins 5 to 7 are not used in the CRP5.

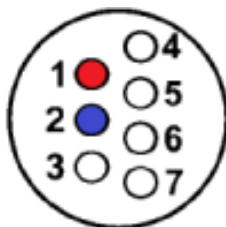

Figure 20: Pinout E2 connection for external HC2 probe

- 1) V+: Digital probe: 3.3 VDC, 10 mA (+)
- 2) GND: Digital and supply ground (-)
- 3) RXD: UART digital probe (receive)
- 4) TXD: UART digital probe (transmit)
- 5) ANA IN: Analog input: 0...3.2 V / 0...25 mA
- 6) NU: Not used
- 7) AGND: (Analog GND)

E-M-CRP5-V1_02_EN.docx Document Code	Rotronic AG Bassersdorf, Switzerland Unit
CRP5 Clean Room Panel Instruction Manual Document Title	Instruction Manual Document Type
	Page 19 of 39

4 Information on Use

4.1 Signal Cables

The following guidelines are derived from the European standard EN 50170 for the transmission of signals by copper wires. Note on installation planning: when determining the position of machinery and equipment, the rules given in EN 50170 should be followed with due regard to local circumstances.

The CRP5 is tested for electromagnetic compatibility according to the EMC Directive 2004/108/EC and the following European standards:

- EN 61000-6-1: 2007, EN 61000-6-2: 2005, EN61326-1:2013
- EN 61000-6-3: 2007+A1:2011+AC:2012, EN 61000-6-4: 2007+A1:2011

Whenever the level of electromagnetic interference is expected to be high, both the devices and signal cables should be placed as far away as possible from the source of interference.

In general, signal cables should be installed in bundles or channels / conduits, separate from other cables as indicated in the table below:

<ul style="list-style-type: none"> • Bus signals such as RS-485 • Data signals for PCs, printers, etc. • Shielded analog inputs • Unshielded DC voltage (≤ 60 V) • Shielded process signals (≤ 25 V) • Unshielded AC voltage (≤ 25 V) • Coaxial cables for CRT monitors 	in common bundles or channels / conduits
<ul style="list-style-type: none"> • DC voltage from 60 V to 400 V (unshielded) • AC voltage from 25 V to 400 V (unshielded) 	in separated bundles or channels / conduits, without minimum distance
<ul style="list-style-type: none"> • DC and AC voltage > 400 V (unshielded) • Telephone lines • Lines leading into EX-rated areas 	in separated bundles or channels / conduits, without minimum distance

E-M-CRP5-V1_02_EN.docx Document Code	Rotronic AG Bassersdorf, Switzerland Unit
CRP5 Clean Room Panel Instruction Manual Document Title	Instruction Manual Document Type
	Page 20 of 39

4.2 Differential Pressure Measurement

4.2.1 Influence of the Ambient Pressure

The measuring accuracy of the integrated differential pressure sensor is not dependent on the local absolute ambient air pressure.

4.2.2 Influence of Dust, Temperature and Humidity

Since the differential pressure sensor evaluates the air pressure difference between its two inputs without air flowing through it, dust particles do not enter the inlet tubes and reach the sensor. The device is thus largely insensitive to dust in the air being measured.

4.2.3 Units

The default analog input unit is mV / mA. A user-specific unit can be configured in the ROTRONIC HW4 software (e.g. %, mbar, etc.). There is a maximum of four characters available for this. If three pre-decimal positions are relevant, the decimal is rounded to one digit.

4.3 Scaling of the Analog Inputs

The CRP5 has two analog inputs (IN1+ / IN1-, IN2+ / IN2-).

The analog inputs can be switched between voltage and current measurement by Rotronic-HW4-Software or Modbus protocol.

For voltage measurement, the signal range is from 0 to 3'300 [mV]. Internal resistance is greater than 100 [kΩ].

A resistance of 120 [Ω] is used for the current measurement. This results in a signal range of 0 to 27 [mA].

Attention!

The 120 Ohm burden for a current input is programmatically inserted and the user does not need to supply an external resistor.

4.3.1 Scaling of the analog input

The analog input is freely scalable via the Rotronic-HW4-Software or the Modbus protocol.

Note

- Input range for voltage measurement: 0 to 3300 [mV] (by steps of 1 [mV])
- Input range for current measurement: 0 to 27 [mA] (by steps of 1 [mA])
- Negative voltages and currents cannot be measured
- Output range (e.g. display): -9'999 to 32767
- The measuring ranges for voltage and current are secured, but should only be exceeded for very short periods

4.3.2 Calculation of the display value

The display value is calculated from the settings of the input (**Input Range**) and processing range (**Processing Range**).

E-M-CRP5-V1_02_EN.docx Document Code	Rotronic AG Bassersdorf, Switzerland Unit
CRP5 Clean Room Panel Instruction Manual Document Title	Instruction Manual Document Type
	Page 21 of 39

$$\text{Displayed Value} = \frac{(\text{ADC Value} - \text{Range Low}) * (\text{Scale High} - \text{Scale Low})}{(\text{Range High} - \text{Range Low})} + \text{Scale Low}$$

Note

- **Range High** must be greater than **Range Low**
- **Scale High** must be different from **Scale Low**

4.3.3 Units

The unit for the analog input can be selected by the customer via the Rotronic-HW4-Software or the Modbus protocol.

If the user doesn't select his own unit, a basic unit will be selected, depending of the selected measure signal, [mV] for voltage or [mA] for current.

The basic unit will be used only, if the field **Auto Unit** is activated.

Auto Unit	Unit Customer	Unit
Off	(empty)	(empty)
On	(empty)	mV / mA
Off	ppm	ppm
On	ppm	ppm

The **Auto Unit** field can be selected only over the Rotronic-HW4-Software or the Modbus protocol.

4.3.4 Unchanged input and output range

With an unchanged input and output range, the input range corresponds to the input range.

	Input Range		Output Range	
Voltage measurement	Range Low	0 [mV]	Scale Low	0 [mV]
	Range High	3'300 [mV]	Scale High	3'300 [mV]
Current measurement	Range Low	0 [mA]	Scale Low	0 [mA]
	Range High	27 [mA]	Scale High	27 [mA]

The values can only be changed in integer steps

4.3.5 Example voltage measurement:

The input value of **825 [mV]** is shown on the display as the same value of **825 [mV]**.

Calculation:

$$\text{Displayed Value} = \frac{(825 - 0) * (3300 - 0)}{(3300 - 0)} + 0 = 825$$

E-M-CRP5-V1_02_EN.docx	Rotronic AG Bassersdorf, Switzerland
Document Code	Unit
CRP5 Clean Room Panel Instruction Manual	Instruction Manual Document Type
Document Title	Page 22 of 39

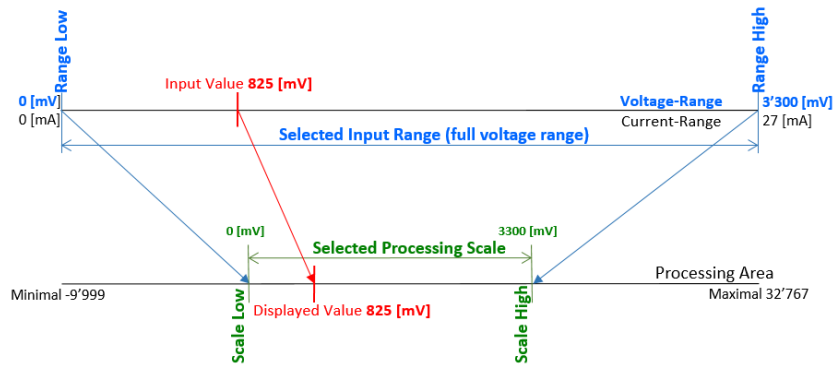

The unit **[mV]** is displayed automatically, if the field **Auto Unit** is selected (Rotronic-HW4-Software or Modbus protocol) and no client-specific unit is selected (see [Units](#)).

4.3.6 Example current measurement:

The input value of **6.75 [mA]** is shown on the display as the same value of **6.75 [mA]**.

Calculation:

$$\text{Displayed Value} = \frac{(6.75 - 0) * (27 - 0)}{(27 - 0)} + 0 = 6.75$$

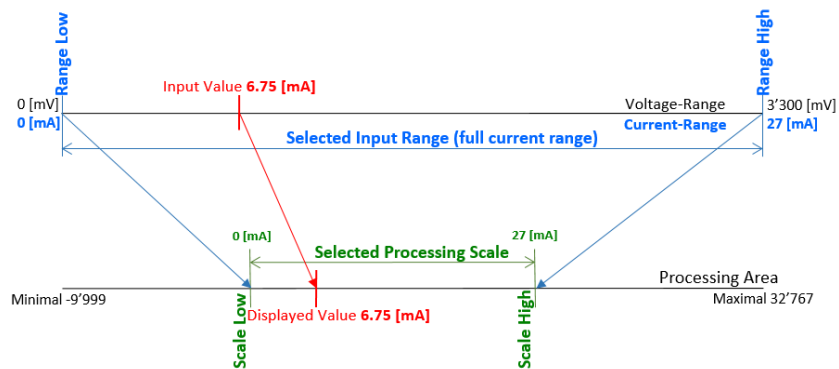

The unit **[mA]** is displayed automatically, if the field **Auto Unit** is selected (Rotronic-HW4-Software or Modbus protocol) and no client-specific unit is selected (see [Units](#)).

4.3.7 Unchanged input range, scaled output range

With an unchanged input range and a scaled output range, the output range can be adapted to the customer's needs. The unit used can be adapted to the output signal.

	Input Range		Output Range	
Voltage measurement	Range Low	0 [mV]	Scale Low	-9'999 bis +32767
	Range High	3'300 [mV]	Scale High	-9'999 bis +32767
Current measurement	Range Low	0 [mA]	Scale Low	-9'999 bis +32767
	Range High	27 [mA]	Scale High	-9'999 bis +32767

The values can only be changed in integer steps

E-M-CRP5-V1_02_EN.docx	Rotronic AG Bassersdorf, Switzerland
Document Code	Unit
CRP5 Clean Room Panel Instruction Manual	Instruction Manual Document Type
Document Title	Page 23 of 39

4.3.8 Example voltage measurement:

The input value in the range of **0** to **3'300 [mV]** will be scaled to the output value in the range of **0** to **2'000 [ppm]**. This means that an input value of **825 [mV]** is shown on the display as a value of **500 [ppm]**.

Calculation:

$$\text{Displayed Value} = \frac{(825 - 0) * (2000 - 0)}{(3300 - 0)} + 0 = 500$$

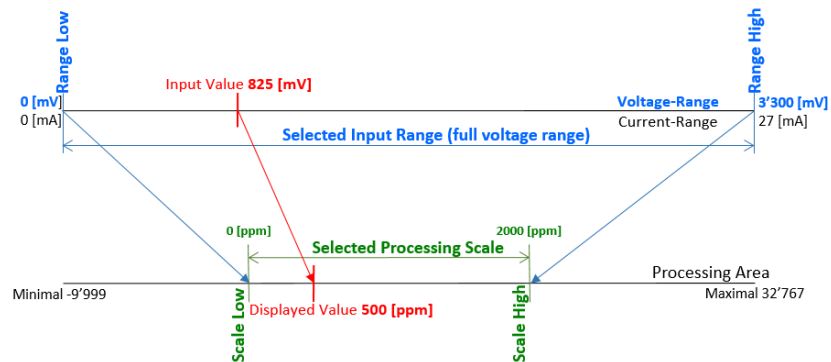

The unit **[ppm]** can be selected by the customer (see [Units](#)).

4.3.9 Example current measurement:

The input value in the range of **0** to **27 [mA]** will be scaled to the output value in the range of **-25** to **100 [°C]**. This means that an input value of **6.75 [mA]** is shown on the display as a value of **6.25 [°C]**.

Calculation:

$$\text{Displayed Value} = \frac{(6.75 - 0) * (100 - -25)}{(27 - 0)} + -25 = 6.25$$

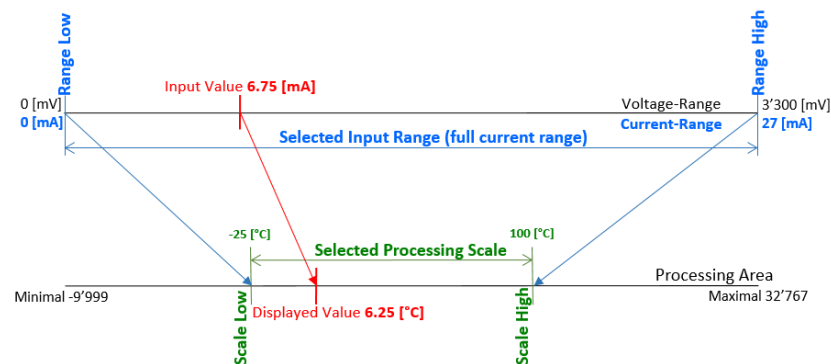

The unit **[°C]** can be selected by the customer (see [Units](#)).

E-M-CRP5-V1_02_EN.docx	Rotronic AG Bassersdorf, Switzerland
Document Code	Unit
CRP5 Clean Room Panel Instruction Manual	Instruction Manual Document Type
Document Title	Page 24 of 39

4.3.10 Modified input range, scaled output range

With a changed input range and a scaled output range, the input and the output ranges can be adapted to the customer's needs. The unit used can be adapted to the output signal

	Input Range		Output Range	
Voltage measurement	Range Low	>= 0 [mV]	Scale Low	-9'999 bis +32767
	Range High	<= 3'300 [mV]	Scale High	-9'999 bis +32767
Current measurement	Range Low	>= 0 [mA]	Scale Low	-9'999 bis +32767
	Range High	<= 27 [mA]	Scale High	-9'999 bis +32767

The values can only be changed in integer steps

4.3.11 Example voltage measurement:

The input value in the range of **400 to 2'500 [mV]** will be scaled to the output value in the range of **800 to 2'000 [ppm]**. This means that an input value of **1'050 [mV]** is shown on the display as a value of **1171.4 [ppm]**.

Calculation:

$$\text{Displayed Value} = \frac{(1050 - 400) * (2000 - 800)}{(2500 - 400)} + 800 = 1171.4$$

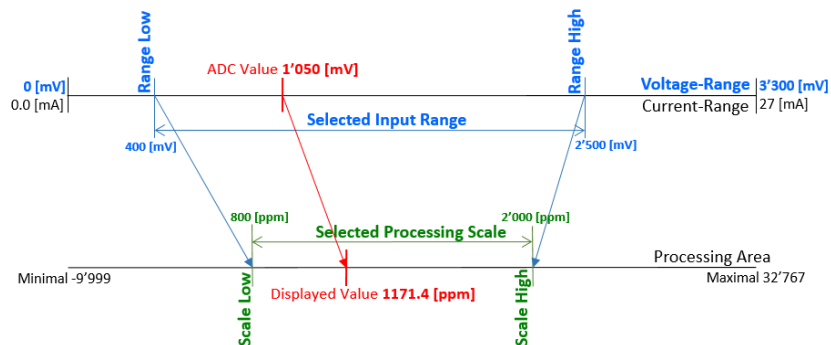

The unit **[ppm]** can be selected by the customer (see [Units](#)).

4.3.12 Example current measurement:

The input value in the range of **4 to 20 [mA]** will be scaled to the output value in the range of **-20 to +100 [°C]**. This means that an input value of **9.6 [mA]** is shown on the display as a value of **22.0 [°C]**.

Calculation:

$$\text{Displayed Value} = \frac{(9.6 - 4) * (100 - -20)}{(20 - 4)} + -20 = 22.0$$

E-M-CRP5-V1_02_EN.docx	Rotronic AG Bassersdorf, Switzerland
Document Code	Unit
CRP5 Clean Room Panel Instruction Manual	Instruction Manual Document Type
Document Title	Page 25 of 39

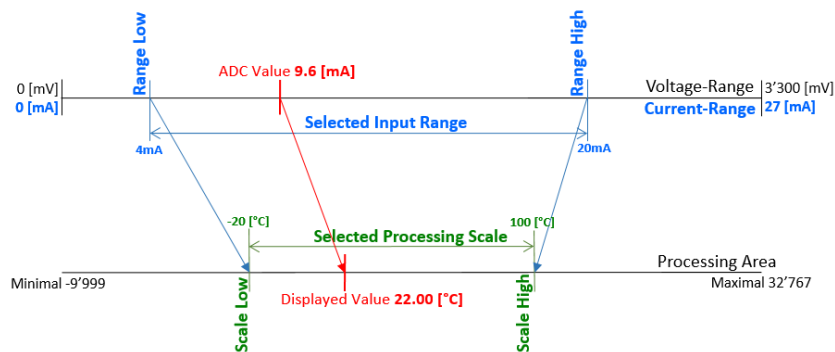

The unit [°C] can be selected by the customer (see [Units](#)).

4.3.13 Output Scale

The display range (Scale = ScaleHi - ScaleLo) of the Display-Value can be selected freely within the complete display range (Display-Scale), but may not exceed the maximum display range of -9,999 ... +99,999.

The output range (Output-Range = RangeHi - RangeLo) of the output signal (Output-Value) can be selected freely within the complete output range (Voltage-/Current-Range), but may not exceed the maximum output range (0 ... 1 V / 0 ... 5 V / 0 ... 10 V / 0 ... 24 mA / 4 ... 24 mA). Fixed values (Fix-Value) are treated in the same way as Display-Values.

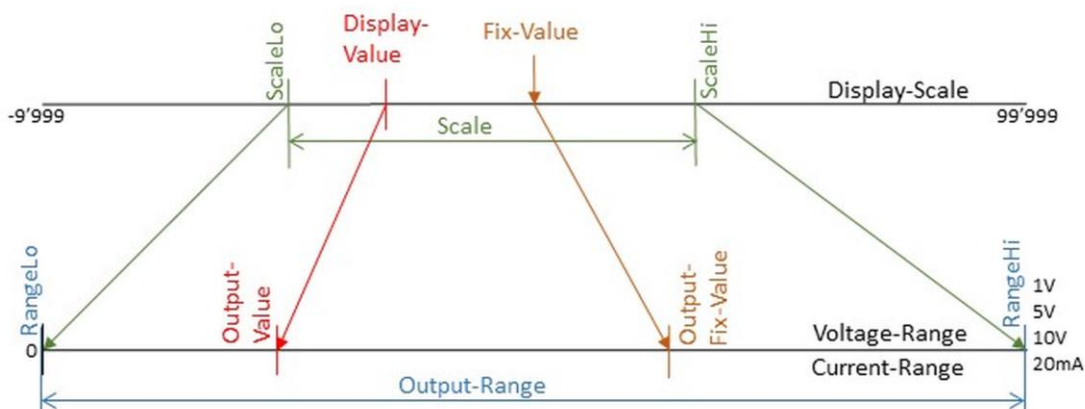

$$\text{Output-Value} = \frac{(\text{Display-Value} - \text{ScaleLo}) * (\text{RangeHi} - \text{RangeLo})}{\text{ScaleHi} - \text{ScaleLo}} + \text{RangeLo}$$

Figure 21: Graphic representation of scaling the analog output





Example:

An external ambient pressure sensor with an analog output of 500...1000 mV (900...1100 hPa) is to be connected and its signal shown in hPa. The Input-Range with the limits RangeLo = 500 mV and RangeHi = 1000 mV and the display range Scale with ScaleLo = 900 and ScaleHi = 1100 mean that an input voltage of 500 mV shows the value 900 in the display and an input voltage of 1000 mV the value 1100. The unit is configured with the ROTRONIC HW4 software as "hPa".

E-M-CRP5-V1_02_EN.docx Document Code	Rotronic AG Bassersdorf, Switzerland Unit
CRP5 Clean Room Panel Instruction Manual Document Title	Instruction Manual Document Type
	Page 26 of 39

4.4 Menu Mode

In menu mode it is possible to configure much of the CRP5 with the keys and display on the front panel without using the ROTRONIC HW4 software. This mode is activated automatically by removing the combined HC2-CRP probe from the front panel or the external HC2 probe from the 7-pin E2 socket at the rear.

Then press the Menu key  to open the screen "Device Information". Five pictograms are shown on the left edge of the display; the keys Up  and Down  are used to navigate to them cyclically. Selecting the pictograms leads, as shown below, to the respective submenus (service menus), which can be selected by pressing the Enter key . It is possible to return to display mode at any time by pressing the Menu key.

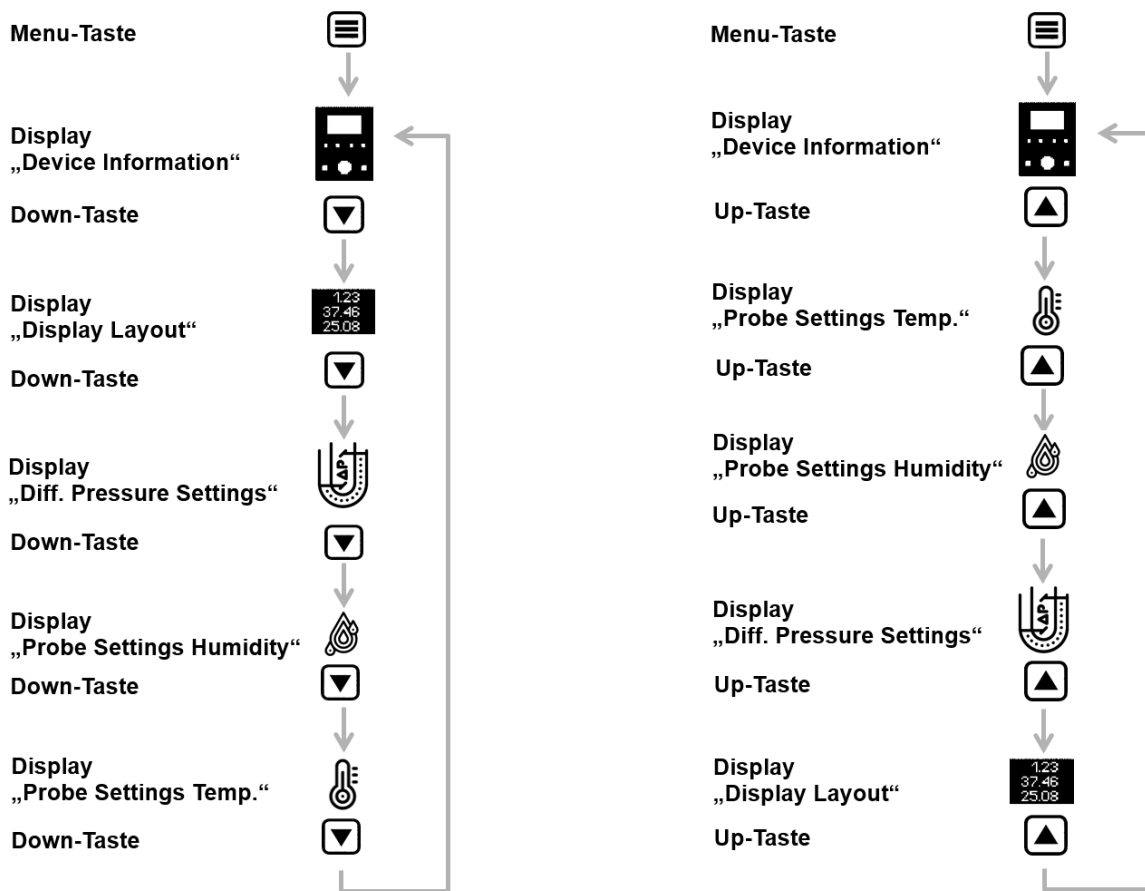

E-M-CRP5-V1_02_EN.docx Document Code	Rotronic AG Bassersdorf, Switzerland Unit
CRP5 Clean Room Panel Instruction Manual Document Title	Instruction Manual Document Type Page 27 of 39



Device Information

This is purely an informative screen. It shows information on the firmware version, serial number, etc. It is not possible to make any settings in it.

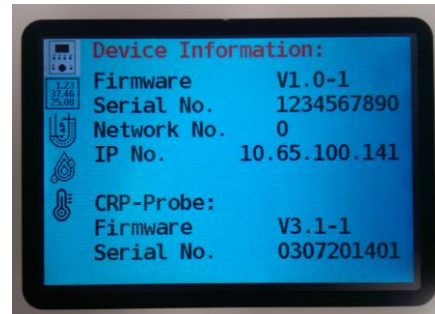
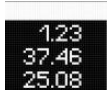

Figure 22: Device Information



Display Layout

This submenu is used to define what is to be shown in the six display lines.



Figure 23: Display Layout



Diff. Pressure Settings

This submenu is used to calibrate and adjust the differential pressure and to select between the front and rear pressure connections.



Figure 24: Diff. Pressure Settings



Probe Settings Humidity

This submenu is used for multipoint adjustment of the humidity sensor with the help of reference humidity values.

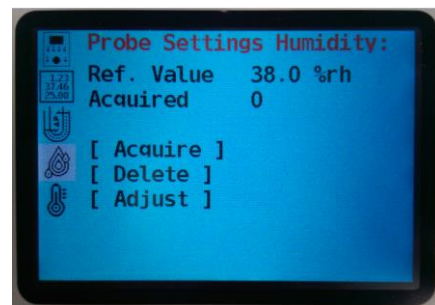

Figure 25: Probe Settings Humidity

<p>E-M-CRP5-V1_02_EN.docx</p> <p>Document Code</p>	<p>Rotronic AG Bassersdorf, Switzerland</p> <p>Unit</p>
<p>CRP5 Clean Room Panel Instruction Manual</p> <p>Document Title</p>	<p>Instruction Manual</p> <p>Document Type</p> <hr/> <p>Page 28 of 39</p>



Probe Settings Temp.

This submenu is used for single-point adjustment of the temperature sensor using a reference temperature.

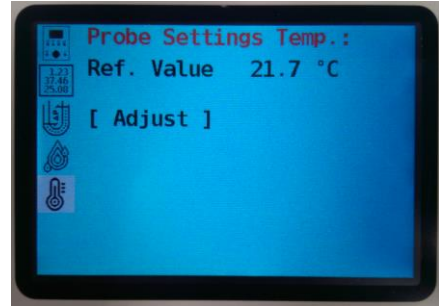

Figure 26: Probe Settings Temp.

E-M-CRP5-V1_02_EN.docx Document Code	Rotronic AG Bassersdorf, Switzerland Unit
CRP5 Clean Room Panel Instruction Manual Document Title	Instruction Manual Document Type Page 29 of 39

4.4.1 Service Menus

Display Layout

When you select the Display Layout menu and press the Enter key, the first list entry Line 1 is highlighted (light background). You can then navigate cyclically from one line to the next (Line 1 to Line 6) with the Up and Down keys. When in the line whose content is to be changed, press the Enter key; the colour of the display text changes to red. You can then move between the available contents with the Up and Down keys. To apply the selected value, press the Enter key again.

Example: Line 4 is to be changed from the preset display of a calculated value (in the example the dew point Dp) to a display of the voltage at Analog Input 2. The following sequence of screens shows which keys need to be pressed for this and their effects in the display.

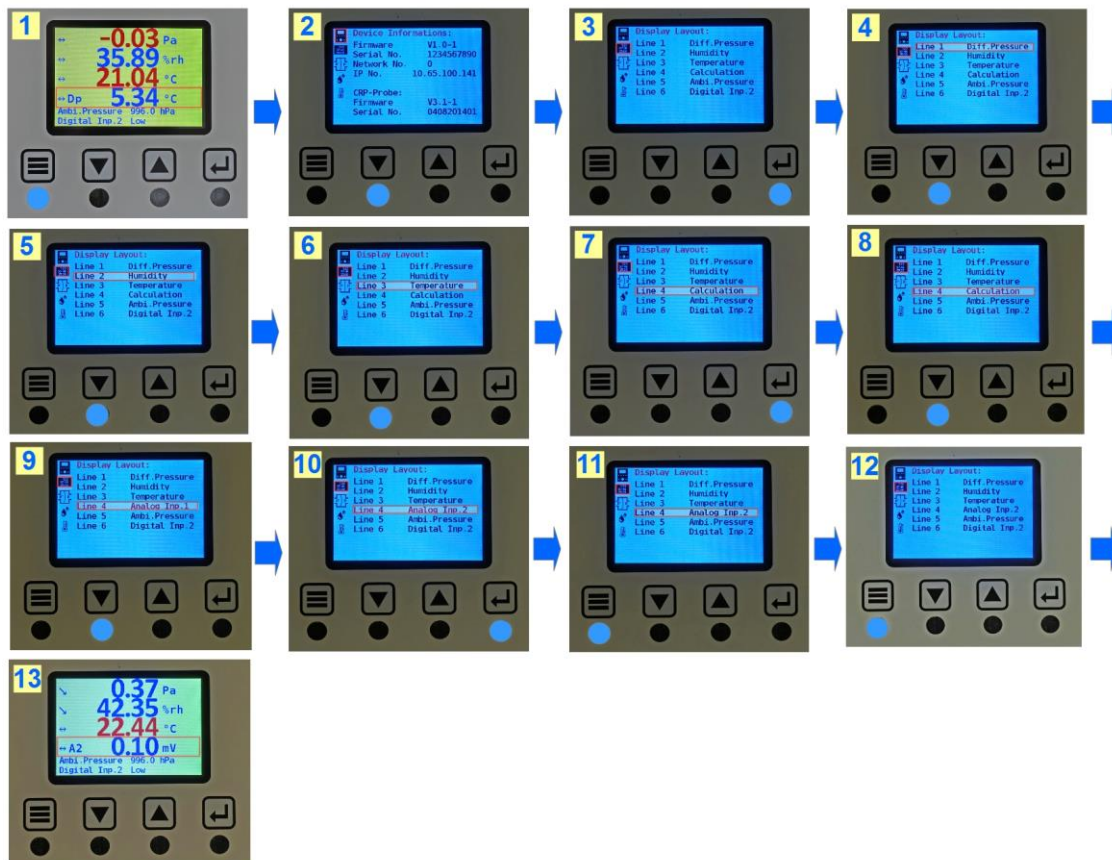

Figure 27: Example of the key sequence to change the display in line 4 from the calculated value Dew Point (Dp) to the voltage value at Analog Input 2 (A2).

E-M-CRP5-V1_02_EN.docx Document Code	Rotronic AG Bassersdorf, Switzerland Unit
CRP5 Clean Room Panel Instruction Manual Document Title	Instruction Manual Document Type Page 30 of 39

The differential pressure sensor, humidity and temperature probe and the corresponding electronics are extremely stable over the long term. They do not normally need to be changed or recalibrated after factory calibration. For maximum accuracy, however, ROTRONIC recommend regular calibration of the device and adjustment when necessary. This can be done with the ROTRONIC HW4 software or the device display. The CRP5 does not need to be opened for calibration/adjustment.

Important: When carrying out calibration or adjustment, make sure you do not move either the sensors or the compressed air tubes.

Differential Pressure Settings

In this submenu it is possible to make the following settings for the differential pressure sensor: Ref. Value (for adjustment of the device), Zero Adjust, Adjust, Reset Adjustment and Calibration. The menu items are selected and the settings entered analogously to the description in the above example for Display Layout.













Probe Settings Humidity

This submenu is used for multipoint adjustment of the humidity sensor. For this, the output values of the humidity sensor are adjusted to various reference values of a humidity standard. The reference points are applied or rejected with [*Acquire*] or [*Delete*] respectively and the probe adjusted out of their totality with [*Adjust*].

The accuracy of a humidity adjustment over the complete measurement range depends on the number of calibration points entered into the probe memory before adjustment.

- One calibration point adds an offset to all measured values.
- Two calibration points influence the offset and gradient of the measurement curve.
- Three or more calibration points influence the offset, gradient and linearity of the measurement curve.

For maximum accuracy, at least three to four calibration points distributed over the measurement range in question should be used. The calibration points (maximum 100) can be entered in any order, but ROTRONIC recommends working from low humidity values to high humidity values.

- When the reference humidity is stable, press the key  to open the main menu in the display.
- Select *Probe Settings Humidity* (humidity adjustment) with the key  and confirm with . The line *Ref. Value* is now selected (black text, white background).
- Pressing  again opens change mode for the line *Ref. Value* (red text, white background). Change the reference value to the humidity reference value with  or . Then leave change mode by pressing the key  again.
- Move to the text line [*Acquire*] with the key  and confirm with . The count in the line *Acquired* is then increased by 1. It therefore shows the current number of calibration points in the probe memory.
- The previous four steps are repeated until the required number of calibration points has been acquired. The calibration point memory is cleared by navigating to the line [*Delete*] and pressing the key .
- Move to the text line [*Adjust*] with the key  and confirm with . The message *Please wait* appears in red for a few seconds. When it disappears again, adjustment is finished. **Only adjust the probe when all calibration points have been acquired!**
- Press the key  twice to leave the menu and return the CRP5 to normal operation.

E-M-CRP5-V1_02_EN.docx Document Code	Rotronic AG Bassersdorf, Switzerland Unit
CRP5 Clean Room Panel Instruction Manual Document Title	Instruction Manual Document Type Page 31 of 39









Note:

- All calibration points are deleted automatically from the probe memory after adjustment.
- The text line [*Delete*] can be used to delete all calibration points before probe adjustment.
- Since the CRP5 does not have a real-time clock, the date of the adjustment is not written in the probe. If it is important to record the adjustment date, use the ROTRONIC HW4 software to adjust the probe.

Probe Settings Temperature

This menu is used for single-point adjustment of the temperature sensor. For this, the measured temperature value is adjusted to the value determined by a reference thermometer. This means that the same offset is added to every measured temperature value.

The procedure step by step:

- When the temperature is stable, press the key  to open the main menu in the display.
- Select *Probe Settings Temp.* (temperature adjustment) with the key  and confirm with . The line *Ref. Value* is now selected (black text, white background).
- Pressing  again opens change mode for the line *Ref. Value* (red text, white background). Change the reference value to the temperature reference value with  or .
- Move to the text line [*Adjust*] with the key  and confirm with . The message *Please wait* appears in red for a few seconds. When it disappears again, adjustment is finished.
- Press the key  twice to leave the menu and return the CRP5 to normal measurement operation.

Note:

- Please follow the principle of temperature adjustment before humidity adjustment!
- Since the CRP5 does not have a real-time clock, the date of the adjustment is not written in the probe. If it is important to record the adjustment date, use the ROTRONIC HW4 software to adjust the probe.

4.5 Service Socket

The Mini-USB-UART service port is located at the rear of the device. It is connected to the USB port of a PC or laptop running the ROTRONIC HW4 software with an AC3006 service cable. The AC3006 service cable implements protocol conversion between UART and USB. It is then possible to make extensive settings to the CRP5.

Note: The CRP5 can only be supplied with power via the AC3006 service cable to a limited extent. Due to the low supply voltage, zeroing and calibration of the differential pressure sensor are not possible. The analog outputs are also not active. These restrictions do not exist when the CRP5 is supplied with power from an external power source via the terminals 2/3 (V-) and 4/5 (V+) at the rear of the device.

4.6 Validation of Analog Output Signals

Using the ROTRONIC HW4 software, it is possible to set fixed values with which the analog output signals can be validated.

E-M-CRP5-V1_02_EN.docx Document Code	Rotronic AG Bassersdorf, Switzerland Unit
CRP5 Clean Room Panel Instruction Manual Document Title	Instruction Manual Document Type
	Page 32 of 39

4.7 Replacement of the HC2-CRP Teflon Filter

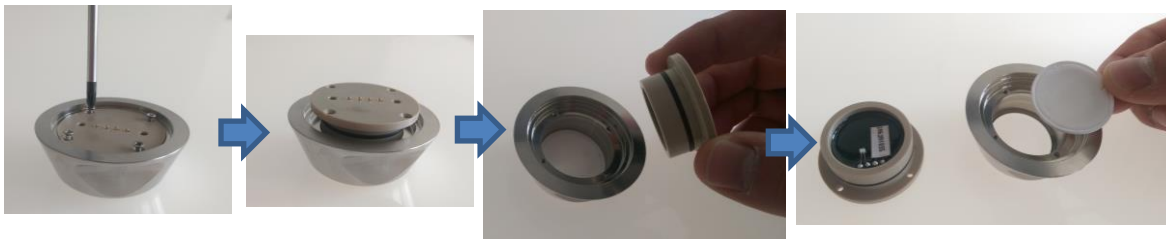

1. Take off the sensor from the CRP5 and unscrew
2. Detach the PEEK housing (use a little force, if necessary, on the filter side)
3. Remove the PEEK housing
4. Replace the Teflon filter



Figure 28: Individual parts of the HC2-CRP

E-M-CRP5-V1_02_EN.docx Document Code	Rotronic AG Bassersdorf, Switzerland Unit
CRP5 Clean Room Panel Instruction Manual Document Title	<div style="text-align: right;"> Instruction Manual Document Type </div> <hr/> Page 33 of 39

5 Firmware Update

Firmware updates are available for downloading on the ROTRONIC website. A PC running ROTRONIC HW4 software is needed for firmware updates. The update can be installed via the path Service Interface > Service Cable AC3006 > PC-USB-Port or IP-Interface or via an IP connection between the CRP5 and the PC. The connection to the computer must remain intact throughout the update process and there must be a stable power supply for the complete duration of the process.

The CRP5 boots automatically after the firmware update.

E-M-CRP5-V1_02_EN.docx	Rotronic AG Bassersdorf, Switzerland
Document Code	Unit
CRP5 Clean Room Panel Instruction Manual	Instruction Manual Document Type
Document Title	Page 34 of 39

6 Technical Data

General

Device type	Panel for measurement of differential pressure, temperature, relative humidity, ambient air pressure and analog input parameters (current or voltage) in a clean room. Supplemented by various analog and digital input and output interfaces as well as freely configurable relay contacts, the CRP5 is equipped for comprehensive measurement, control and regulating applications in clean rooms and their environments.
Type of mounting	Recessed in a wall

General Specifications

Display	Colour TFT LCD, 51 x 75 mm (height x width)
Menu navigation	4 visual keys (for operation with protective gloves)
Housing material	Front: glass; rear: stainless steel
IP protection class	Front: IP65; rear: IP20
Dimensions	180 mm x 300 mm x 72 mm (see technical drawing)
Weight (excl. packaging)	1,700 g with HC2-CRP probe 1,550 g without HC2-CRP probe
Self-heating	+0.21 K at maximum capacity of all inputs and outputs
Startup time	< 5 s
Measurement interval	Min. 1 s (default: 1 s)
Memory function	Via ROTRONIC HW4 software
Simulation	Possible to set fixed values for system validation
Range of application	-5 ... 60 °C / 0...100 %RH, non-condensing
Storage and transport conditions	-5 ... 60 °C / 0...100 %RH, non-condensing
Altitude	To 2,000 MASL
Electrical connections	36-pin cable gland, removable MOK 7-pin (version with HygroClip2 connection) RJ45 Ethernet port
Mechanical connections	2 x 4 mm pressure connections at rear 2 x 6 mm pressure connections at front 4 x 4.3 mm holes for mechanical fastening to corners

Conformity with Standards

	EMC Directive 2004/108/EC: EN 61000-6-1: 2007 EN 61000-6-2: 2005 EN 61000-6-3: 2007+A1:2011+AC:2012 EN 61000-6-4: 2007+A1:2011 EN 61326-1: 2013
CE / EMC immunity	
Solder type	Lead-free (RoHS directive)
Fire protection class	Corresponds to UL94-HB V2
FDA / GAMP directives	CFR21 Part 11 and GAMP5
ROHS	Conforms

E-M-CRP5-V1_02_EN.docx	Rotronic AG Bassersdorf, Switzerland
Document Code	Unit
CRP5 Clean Room Panel Instruction Manual	Instruction Manual
	Document Type
Document Title	Page 35 of 39

Power Supply and Connections

Supply voltage	20 ... 48 VDC / 16 ... 35 VAC, 50/60 Hz
Rated current consumption	< 500 mA
Electrical connections	36-pole terminal strip on rear of device, RJ-45 Ethernet port, Mini-USB service port, E2 socket for external HC2 probe (device-dependent)
Polarity protection	Protective diode on V+

Humidity and Temperature Measurement

With HC2	See document E-M-HC2 Probes >Specifications.
With HC2-CRP	See document E-M-HC2 Probes >Specifications

Differential Pressure Measurement

Measurement ranges	-50 ... +50 Pa / -100 ... +100 Pa / -250 ... +250 Pa / -500 ... +500 Pa
Accuracy	±1.0 %FSS
Response time τ_{63}	1 s, typical
Ambient pressure dependence	None
Pressure resistance	70,000 Pa
Long-term stability	±0.25 %FSS/year
Adjustment points	2 points, zero and reference point
Resolution	0.01 Pa
Sensor test	Sensor alarm on short circuit, interruption or defect

Ambient Pressure Sensor

Absolute accuracy	±1 hPa (0...65 °C; 950...1100 hPa) max.
Relative accuracy	0.12 hPa (25 °C; 950...1050 hPa) typical
Temperature coefficient offset	1.5 Pa/K (+25...40 °C @ 900 hPa)
Working range - pressure	300...1100 hPa
Working range - temperature	-5...65 °C

Analog Inputs

Number	2
Measurement range	Voltage: 0...3.3 V Current: 0...25 mA
Accuracy	0.5% of current measured value
Input resistance	>100 k Ω

Digital Inputs

Number	2
Input voltage	0...24 V, freely configurable
Switching thresholds (default)	High: 3.5 V Low: 1.5 V
Input resistance	10 k Ω

E-M-CRP5-V1_02_EN.docx	Rotronic AG Bassersdorf, Switzerland
Document Code	Unit
CRP5 Clean Room Panel Instruction Manual	Instruction Manual Document Type
Document Title	Page 36 of 39

Calculated Parameters

Psychrometric parameters	Dew point (Dp) above and below freezing point Frost point (Fp) below freezing point and dew point above freezing point Wet bulb temperature (Tw) Enthalpy (H) Vapor concentration (Dv) Specific humidity (Q) Mixing ratio by weight (R) Vapor concentration at saturation (Dvs) Vapor partial pressure (E) Vapor saturation pressure (Ew)
--------------------------	--

Analog Outputs

Outputs 1, 2, 3, 4	Can be assigned to every parameter
Default parameters	Differential pressure, relative humidity, temperature
Default range	Per order code
Signal type	Freely scalable 0...20 mA (default: 4...20 mA) 0...10 V
Accuracy (at 23 °C)	±1 mV/V (voltage output) ±20 µA (current output)
User-configurable range limits	-9,999...+9,999 units
Refresh interval	1 s
Short circuit tolerant	Yes
Maximum load	500 Ω (current output)
Load compensation	Yes
Minimum load resistance	1000 Ω (voltage output)
Load influence compensation	Yes
Resolution	16 bit

Relay

Number of relays	6
Type of relays	FET (solid-state relay)
Switching capacity	DC voltage: 50 VDC @ 2 A, observe polarity AC voltage: 35 VAC @ 1 A, polarity arbitrary

Digital Interfaces

- Ethernet, wired (10 Base T or 100 Base T)
- RS485
- UART service interface

Protocols

- Modbus TCP/IP
- Modbus RTU
- Rotronic-ASCII-Protocol

Service Socket





Interface type	UART (Universal Asynchronous Receiver Transmitter)
Connection	Mini-USB
Max. length of service cable	5 m (16.4 ft)

E-M-CRP5-V1_02_EN.docx Document Code	Rotronic AG Bassersdorf, Switzerland Unit
CRP5 Clean Room Panel Instruction Manual Document Title	Instruction Manual Document Type
	Page 37 of 39

7 Accessories

Order Code	Description	
AC3006	Service cable with protocol converter USB ↔ UART	
AC6001	Connection tube Diameter 4 mm	
AC6101	Mounting kit 2 pc. wall holders 290 mm x 10 mm x 3 mm	
AC6102	Mounting screws 4 pc. PEEK M4x16	
AC6100	Pressure cap without bore	
AC6101	Pressure cap with bore	No illustration
ER-CRP	Standard calibration holder	
ER-CRP-HG2	Calibration holder for HygroGen2	No illustration
SP-CRP	Teflon filter for HC2-CRP	No illustration

E-M-CRP5-V1_02_EN.docx Document Code	Rotronic AG Bassersdorf, Switzerland Unit
CRP5 Clean Room Panel Instruction Manual Document Title	Instruction Manual Document Type
	Page 38 of 39

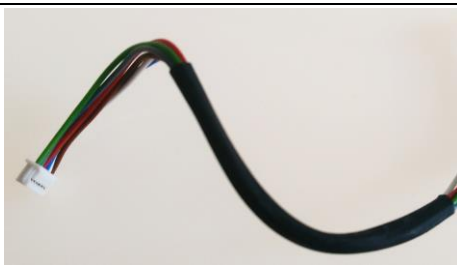
HC2-CRP-SET	Humidity and temperature probe HC2-CRP including holder	
HC2-CRP	Humidity and temperature probe HC2-CRP	
HC2-CRP-HOLDER	Holder for humidity and temperature probe HC2-CRP	
A-01-PB	1 m cable A (HC2 connection) to PicoBlade (connection of HC2-CRP-HOLDER)	
A-02-PB	2 m cable A (HC2 connection) to PicoBlade (connection of HC2-CRP-HOLDER)	
A-05-PB	5 m cable A (HC2 connection) to PicoBlade (connection of HC2-CRP-HOLDER)	
PB-10-XX	1 cm PicoBlade (connection of HC2-CRP-HOLDER) to open ends	

E-M-CRP5-V1_02_EN.docx Document Code	Rotronic AG Bassersdorf, Switzerland Unit
CRP5 Clean Room Panel Instruction Manual Document Title	Instruction Manual Document Type
	Page 39 of 39

8 Additional Documents

Document Name	Contents
E-M-HC2 Probes	HC2 manual
E-M-HW4v3-Main	HW4 software main manual
E-M-TCPIP-Conf	Manual for Ethernet configuration of ROTRONIC instruments
E-M-AC3000-CP	Communication protocol for all AirChip3000 instruments
E-M-HW4v3-P-002_10	HW4 software manual for CRP5
D-MCRP5-MODBUS	Modbus RTU manual for CRP5
D-M-CRP5	CRP5 manual

9 Document Versions

Doc. Release	Date	Remark
D-M-CRP5-V1_0	January 2016	Release document
E-M-CRP5-V1_1	January 2018	Modified analogue output
E-M-CRP5-V1_02	March 2018	Information boxes added in chapter 1 & 4